



**STARGATE**  
— GLOBAL SOLUTIONS —

# Motorized Louvered Pergola

[WWW.STARGATE.LTD](http://WWW.STARGATE.LTD)

# Motorized Louvered Pergola

Motorized Louvered Pergola is weather-resistant and durable, has 20 years service lifetime.

The Motorized Louvered Pergola is made of Aluminum alloy, could be adjusted the perfect blend of sun and shade at the touch of a button. When the Louvers are open, sunlight and breeze can enter from a specified angle; when the Louvers are closed, the sunlight and rainwater are completely blocked, and the rainwater can flow away along the established drainage groove.

## Kinds Of Combination

The reference of combination

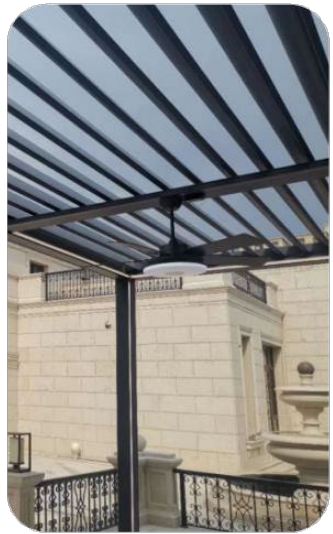

With fan



With Zipscreen



With sliding glass door

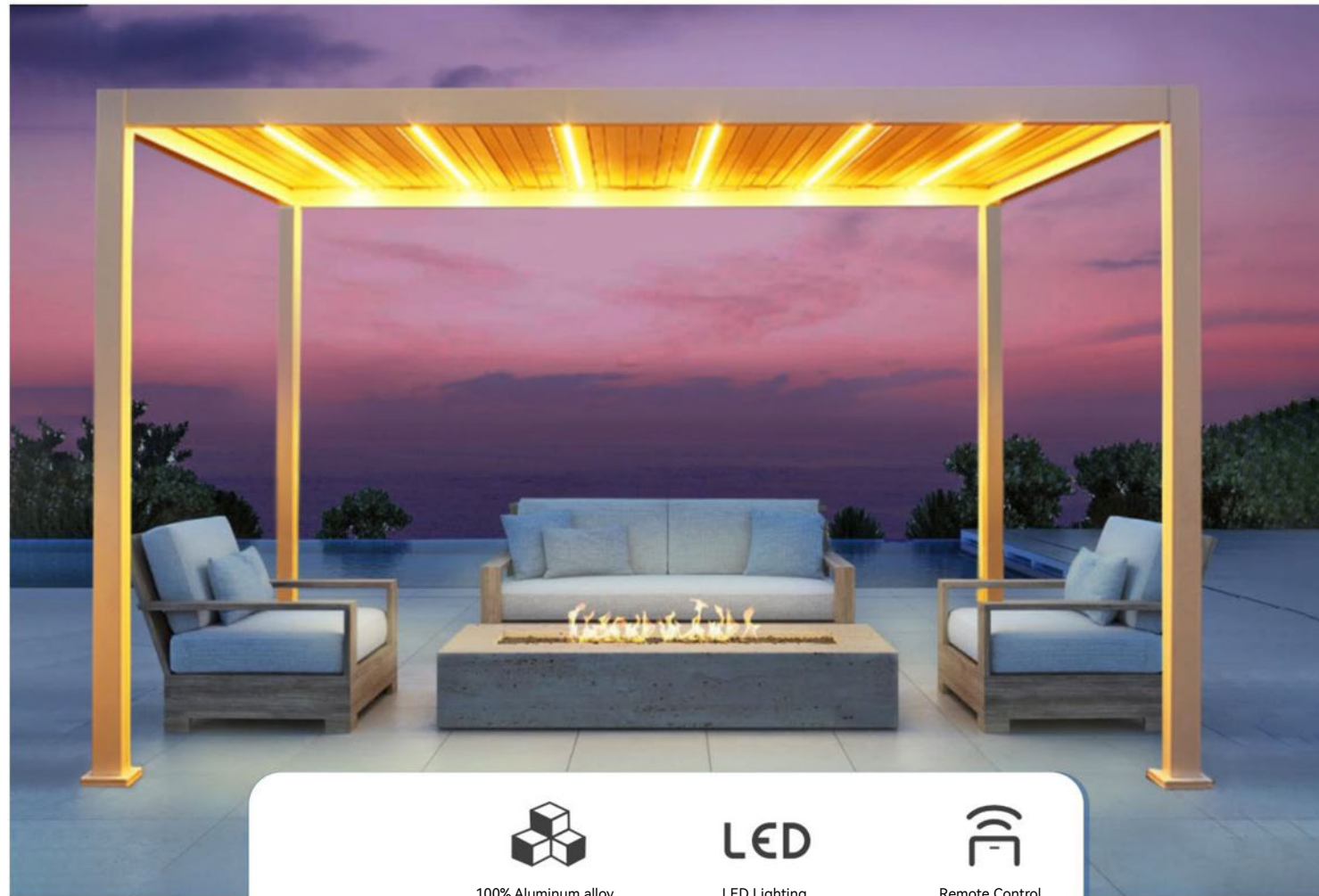

Motorized Louvered Pergola



100% Aluminum alloy

LED

LED Lighting



Remote Control



Wind Break



Waterproof



Shade

# Product Details

## HIGH-QUALITY MATERIAL EXCELLENT FUNCTION

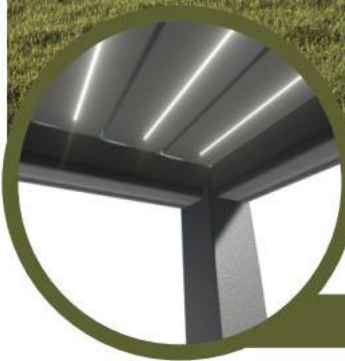

Environmental friendly spraying material

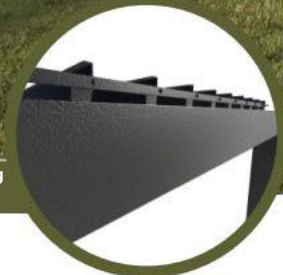

Featured Aluminum alloy material

Built-in environmental friendly light strip in Louvered roof

## DETAILS

Perfect connection between columns and beams as a result of Scientific internal groove design,the built-in screws are to make it stronger and look simple.

Some other's Louvered Pergola put screws on surface of materials in order to connect columns and beams,looks unsightly.



VS



### NO SCREW ON SURFACE, LOOKS SIMPLE AND NICE

We consider the Wholeness of Louvered Pergola,try our best to hide the screws and make the overall lines more smooth in view.



# About This Product

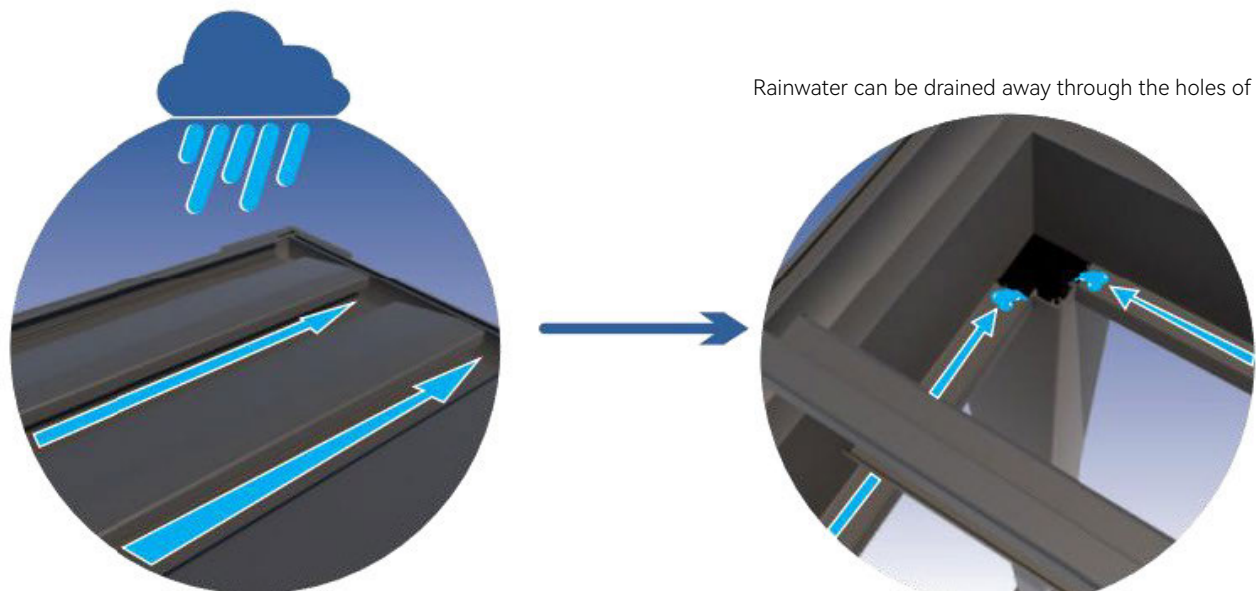
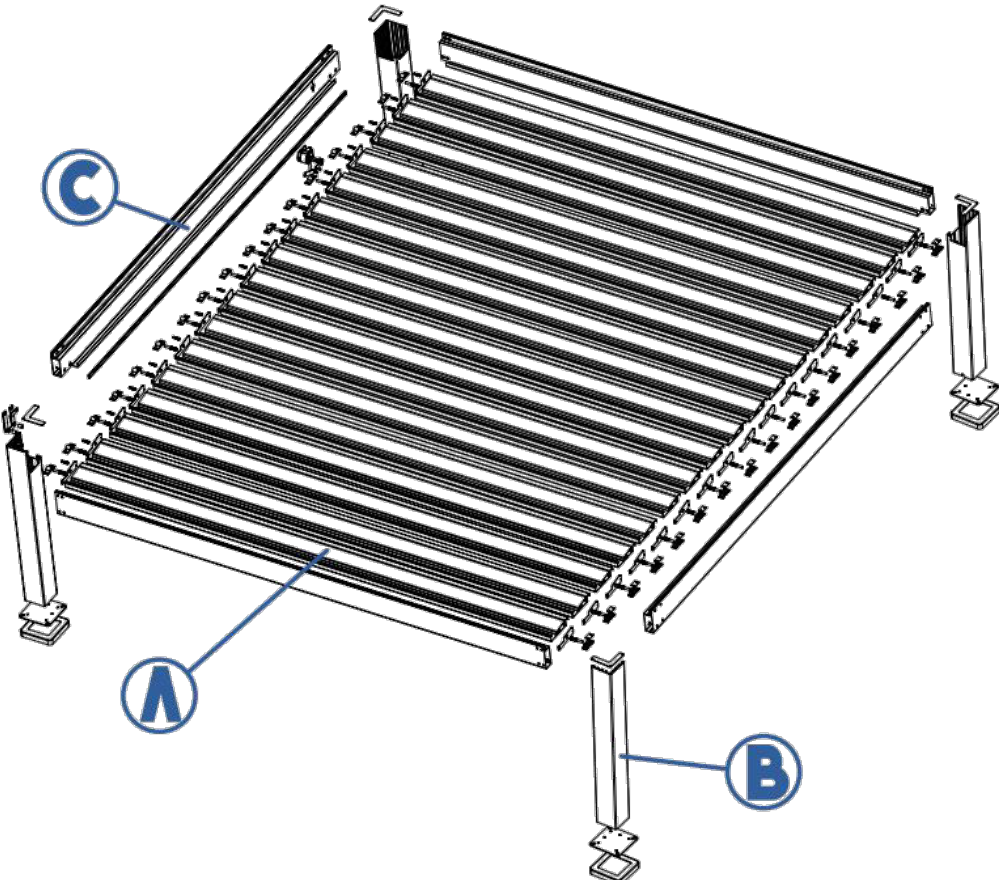

Rainwater can be drained away through the holes of Columns

If it's rainy day, the rainwater will flow down the grooves of the louvers to the gutters

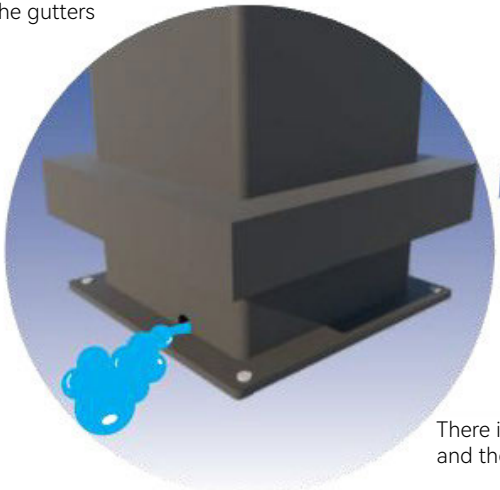

There is a drainage port at the bottom of the column, and the rainwater will flow to the outdoors

Serial number	Component	Size (mm)	Cross section
<b>A</b>	Louver	168*35*1.5	
<b>B</b>	Gutter	140*85*1.5	
<b>C</b>	Column	120*120*1.5	

# Size and Scenario shows

## DETAIL

**HOT SALE SIZE**

← WIDTH →	← EXTENSION →	HEIGHT ↑
300	300	270
300	400	270

About size, we have enough stock of all hot sale size, all good price, if you want to receive a proposal for the manufacture and measure, request a consultation today.



Standard remote control system  
Standard color: Ivory white, galaxy gray



Combination:  
Quadruped support (Single/double)

## SCENARIO SHOWS



**STARGATE**  
— GLOBAL SOLUTIONS —

**MORE**





# Case



**STARGATE**  
— GLOBAL SOLUTIONS —

[WWW.STARGATE.LTD](http://WWW.STARGATE.LTD)

Ready to source smarter? Get your personalised quote — fast.

WhatsApp: +27 79 721 1109

Email: [info@stargate.ltd](mailto:info@stargate.ltd)

Or scan the QR code:



Simply share your **name, company, delivery address,**  
**and the products you need** (reference numbers or screenshots)  
with **quantities** — our team takes care of the rest.